

PRODUCT FEATURES

- IGBT CHIP(Trench+Field Stop technology)
- $V_{CE(sat)}$ with positive temperature coefficient
- High short circuit capability
- Fast switching and short tail current
- Free wheeling diodes with fast and soft reverse recovery
- Low switching losses



APPLICATIONS

- High frequency switching application
- Medical applications
- Motion/servo control
- UPS systems

IGBT-inverter

ABSOLUTE MAXIMUM RATINGS($T_C=25^\circ\text{C}$ unless otherwise specified)

Symbol	Parameter/Test Conditions		Values	Unit
V_{CES}	Collector Emitter Voltage	$T_J=25^\circ\text{C}$	1200	V
V_{GES}	Gate Emitter Voltage		± 20	
I_C	DC Collector Current	$T_C=25^\circ\text{C}, T_{Jmax}=175^\circ\text{C}$	438	A
		$T_C=95^\circ\text{C}, T_{Jmax}=175^\circ\text{C}$	300	
I_{CM}	Repetitive Peak Collector Current	$t_p=1\text{ms}$	600	
P_{tot}	Power Dissipation Per IGBT	$T_C=25^\circ\text{C}, T_{Jmax}=175^\circ\text{C}$	1500	W

Diode-inverter

ABSOLUTE MAXIMUM RATINGS ($T_C=25^\circ\text{C}$ unless otherwise specified)

Symbol	Parameter/Test Conditions		Values	Unit
V_{RRM}	Repetitive Reverse Voltage	$T_J=25^\circ\text{C}$	1200	V
$I_{F(AV)}$	Average Forward Current		300	A
I_{FRM}	Repetitive Peak Forward Current	$t_p=1\text{ms}$	600	
I^2t		$T_J=125^\circ\text{C}, t=10\text{ms}, V_R=0\text{V}$	19000	A^2s

MacMic Science & Technology Co., Ltd.

Add: #18, Hua Shan Zhong Lu, New District, Changzhou City, Jiangsu Province, P. R. of China

Tel.: +86-519-85163708 Fax: +86-519-85162291 Post Code: 213022 Website: www.macmicst.com

MMG300D120B6TC

IGBT-inverter

ELECTRICAL CHARACTERISTICS ($T_C=25^\circ\text{C}$ unless otherwise specified)

Symbol	Parameter/Test Conditions		Min.	Typ.	Max.	Unit	
$V_{GE(th)}$	Gate Emitter Threshold Voltage	$V_{CE}=V_{GE}, I_C=12\text{mA}$	5.0	5.8	6.5	V	
$V_{CE(sat)}$	Collector - Emitter Saturation Voltage	$I_C=300\text{A}, V_{GE}=15\text{V}, T_J=25^\circ\text{C}$		1.85	2.25		
		$I_C=300\text{A}, V_{GE}=15\text{V}, T_J=125^\circ\text{C}$		2.15			
		$I_C=300\text{A}, V_{GE}=15\text{V}, T_J=150^\circ\text{C}$		2.2			
I_{CES}	Collector Leakage Current	$V_{CE}=1200\text{V}, V_{GE}=0\text{V}, T_J=25^\circ\text{C}$			1	mA	
		$V_{CE}=1200\text{V}, V_{GE}=0\text{V}, T_J=150^\circ\text{C}$			10		
I_{GES}	Gate Leakage Current	$V_{CE}=0\text{V}, V_{GE}=\pm 20\text{V}, T_J=25^\circ\text{C}$	-400		400	nA	
R_{Gint}	Integrated Gate Resistor			1.8		Ω	
Q_G	Gate Charge	$V_{CE}=600\text{V}, I_C=300\text{A}, V_{GE}=15\text{V}$		1.5		μC	
C_{ies}	Input Capacitance	$V_{CE}=25\text{V}, V_{GE}=0\text{V}, f=1\text{MHz}$		21		nF	
C_{res}	Reverse Transfer Capacitance				1		nF
$t_{d(on)}$	Turn on Delay Time	$V_{CC}=600\text{V}, I_C=300\text{A}$ $R_G=2.7\Omega,$ $V_{GE}=\pm 15\text{V},$ Inductive Load	$T_J=25^\circ\text{C}$		120		ns
			$T_J=125^\circ\text{C}$		140		ns
			$T_J=150^\circ\text{C}$		150		ns
t_r	Rise Time	$V_{GE}=\pm 15\text{V},$ Inductive Load	$T_J=25^\circ\text{C}$		70		ns
			$T_J=125^\circ\text{C}$		75		ns
			$T_J=150^\circ\text{C}$		80		ns
$t_{d(off)}$	Turn off Delay Time	$V_{CC}=600\text{V}, I_C=300\text{A}$ $R_G=2.7\Omega,$ $V_{GE}=\pm 15\text{V},$ Inductive Load	$T_J=25^\circ\text{C}$		440		ns
			$T_J=125^\circ\text{C}$		500		ns
			$T_J=150^\circ\text{C}$		520		ns
t_f	Fall Time	$V_{GE}=\pm 15\text{V},$ Inductive Load	$T_J=25^\circ\text{C}$		100		ns
			$T_J=125^\circ\text{C}$		180		ns
			$T_J=150^\circ\text{C}$		200		ns
E_{on}	Turn on Energy	$V_{CC}=600\text{V}, I_C=300\text{A}$ $R_G=2.7\Omega,$ $V_{GE}=\pm 15\text{V},$ Inductive Load	$T_J=125^\circ\text{C}$		52		mJ
			$T_J=150^\circ\text{C}$		54		mJ
E_{off}	Turn off Energy	$V_{GE}=\pm 15\text{V},$ Inductive Load	$T_J=125^\circ\text{C}$		29		mJ
			$T_J=150^\circ\text{C}$		32		mJ
I_{SC}	Short Circuit Current	$tp_{sc} \leq 10\mu\text{s}, V_{GE}=15\text{V}$ $T_J=150^\circ\text{C}, V_{CC}=800\text{V}$		1100		A	
R_{thJC}	Junction to Case Thermal Resistance (Per IGBT)				0.1	K/W	

MMG300D120B6TC

Diode-inverter

ELECTRICAL CHARACTERISTICS ($T_C=25^\circ\text{C}$ unless otherwise specified)

Symbol	Parameter/Test Conditions	Min.	Typ.	Max.	Unit	
V_F	Forward Voltage	$I_F=300\text{A}, V_{GE}=0\text{V}, T_J=25^\circ\text{C}$		1.7	2.15	V
		$I_F=300\text{A}, V_{GE}=0\text{V}, T_J=125^\circ\text{C}$		1.65		
		$I_F=300\text{A}, V_{GE}=0\text{V}, T_J=150^\circ\text{C}$		1.65		
t_{rr}	Reverse Recovery Time	$I_F=300\text{A}, V_R=600\text{V}$ $di_F/dt=-3000\text{A}/\mu\text{s}$ $T_J=150^\circ\text{C}$		600		ns
I_{RRM}	Max. Reverse Recovery Current			201		A
Q_{RR}	Reverse Recovery Charge			49.4		μC
E_{rec}	Reverse Recovery Energy			17		mJ
R_{thJCD}	Junction to Case Thermal Resistance (Per Diode)			0.15		K/W

MODULE CHARACTERISTICS ($T_C=25^\circ\text{C}$ unless otherwise specified)

Symbol	Parameter/Test Conditions	Values	Unit	
T_{Jmax}	Max. Junction Temperature	175	$^\circ\text{C}$	
T_{Jop}	Operating Temperature	-40~150		
T_{stg}	Storage Temperature	-40~125		
V_{isol}	Isolation Breakdown Voltage	AC, 50Hz(R.M.S), t=1minute	3000	V
CTI	Comparative Tracking Index		> 225	
Torque	to heatsink	Recommended (M6)	3~5	Nm
	to terminal	Recommended (M6)	2.5~5	Nm
Weight			300	g

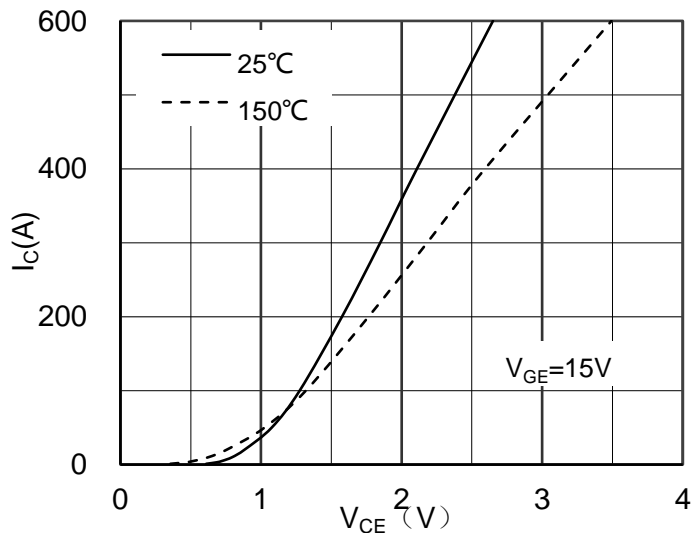

Figure 1. Typical Output Characteristics IGBT-inverter

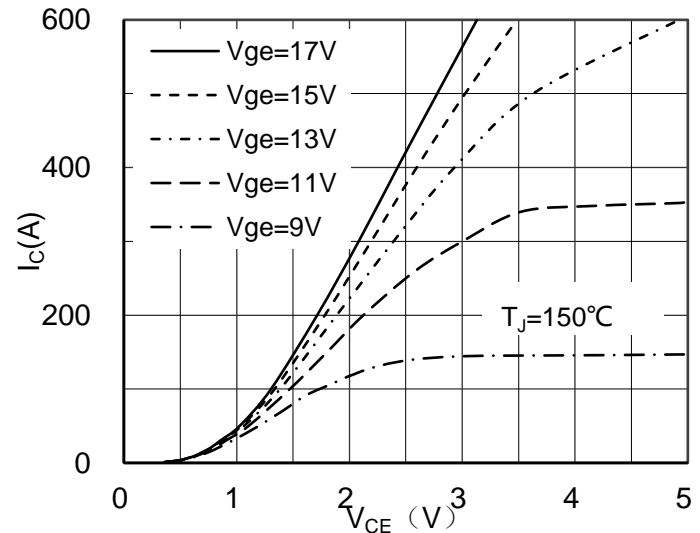

Figure 2. Typical Output Characteristics IGBT-inverter

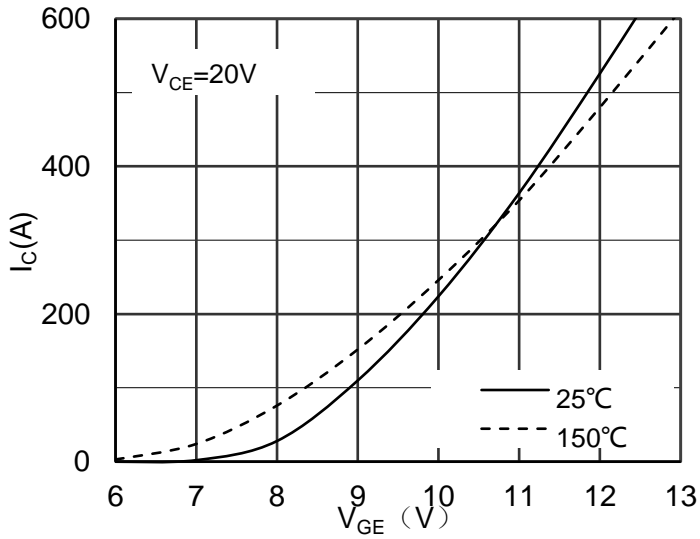

Figure 3. Typical Transfer characteristics IGBT-inverter

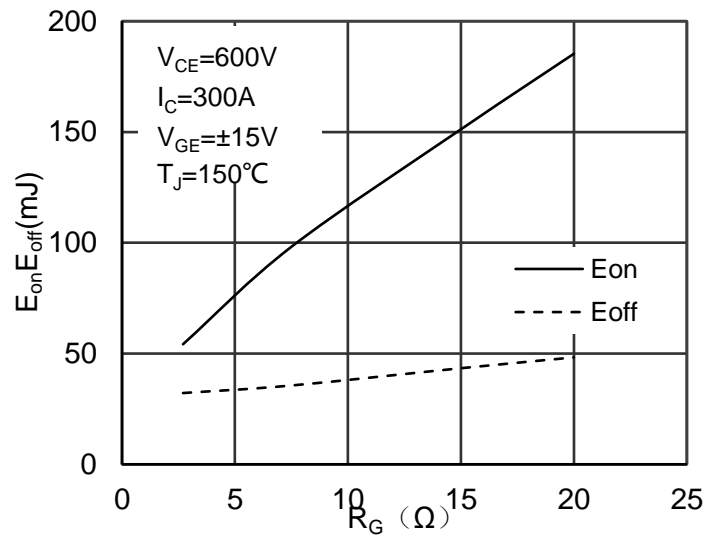

Figure 4. Switching Energy vs Gate Resistor IGBT-inverter

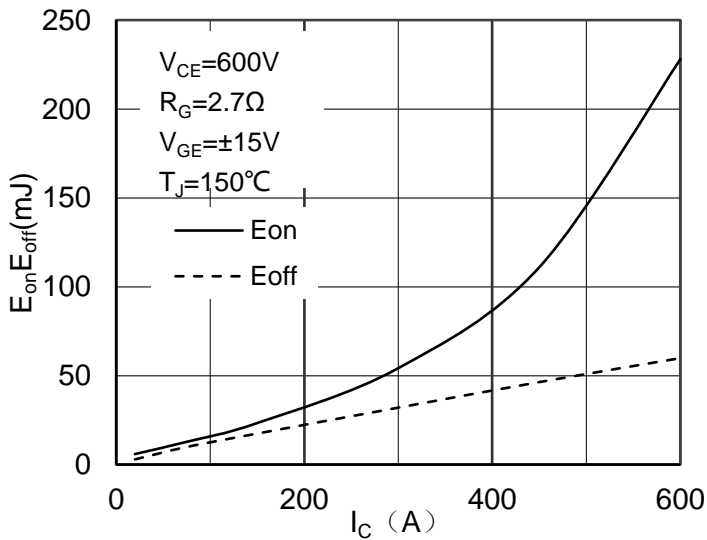

Figure 5. Switching Energy vs Collector Current IGBT-inverter

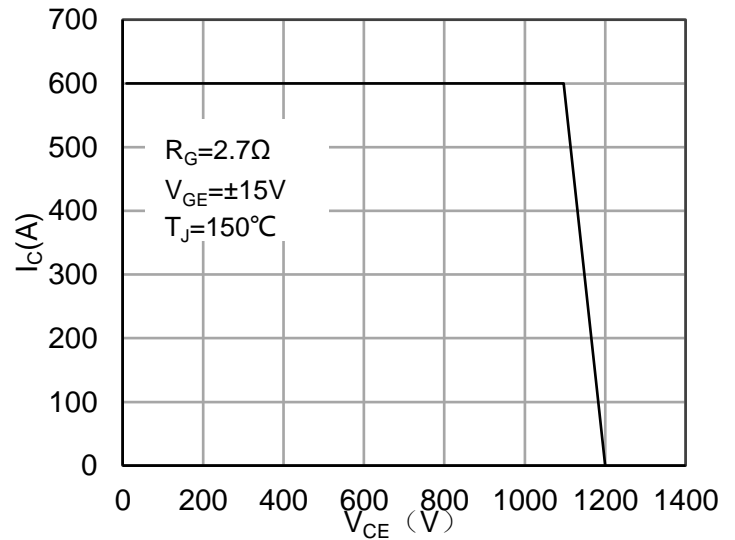

Figure 6. Reverse Biased Safe Operating Area IGBT-inverter

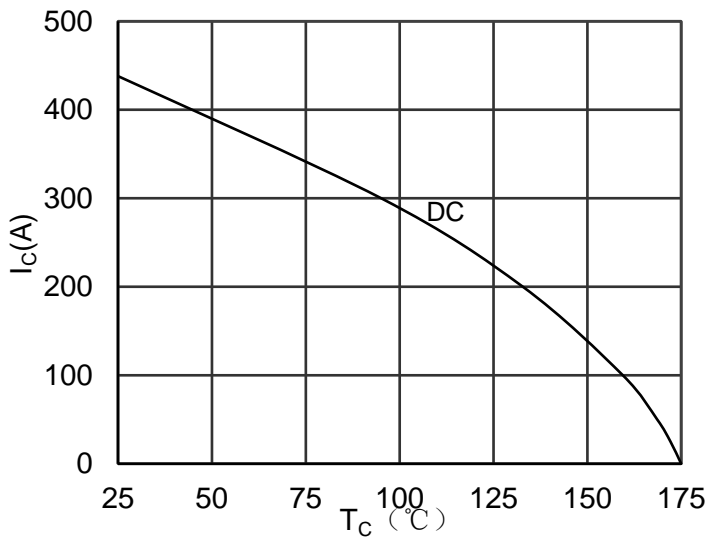

Figure 7. Collector Current vs Case temperature IGBT-inverter

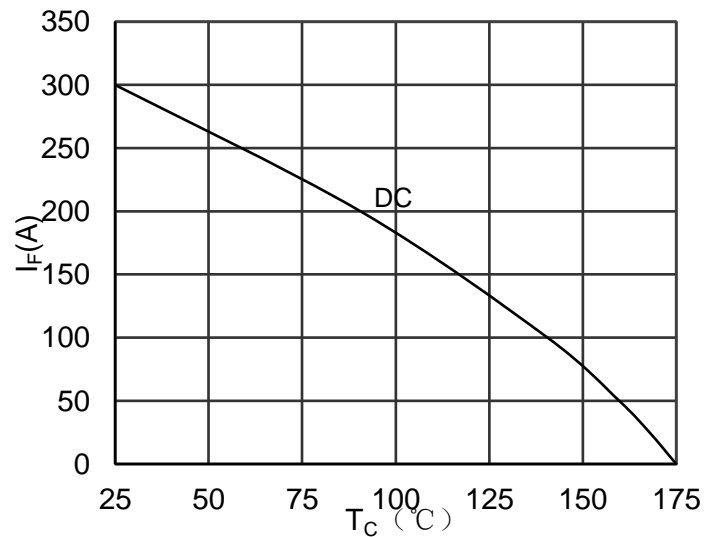

Figure 8. Forward current vs Case temperature Diode-inverter

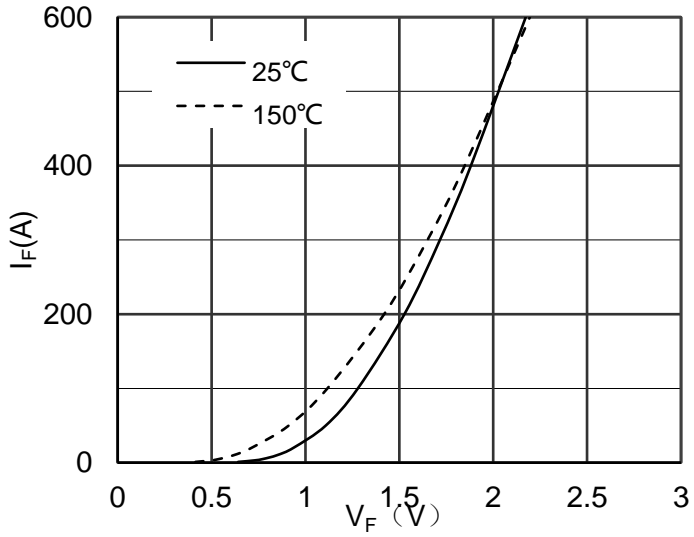

Figure 9. Diode Forward Characteristics Diode -inverter

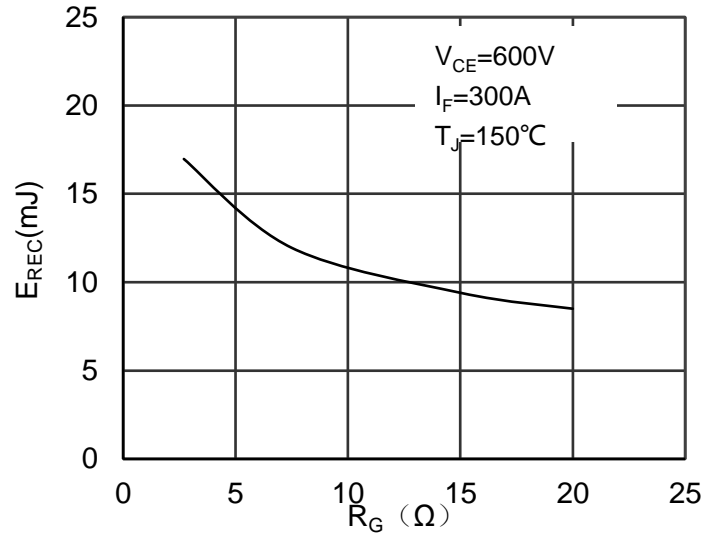

Figure 10. Switching Energy vs Gate Resistor Diode -inverter

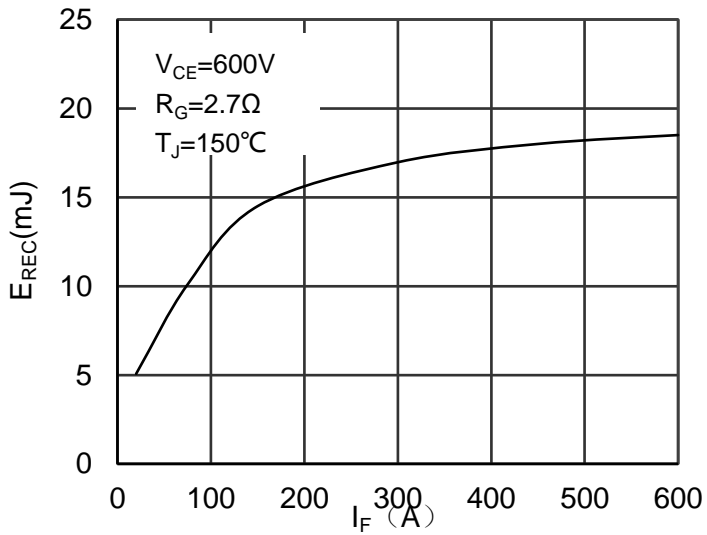

Figure 11. Switching Energy vs Forward Current Diode-

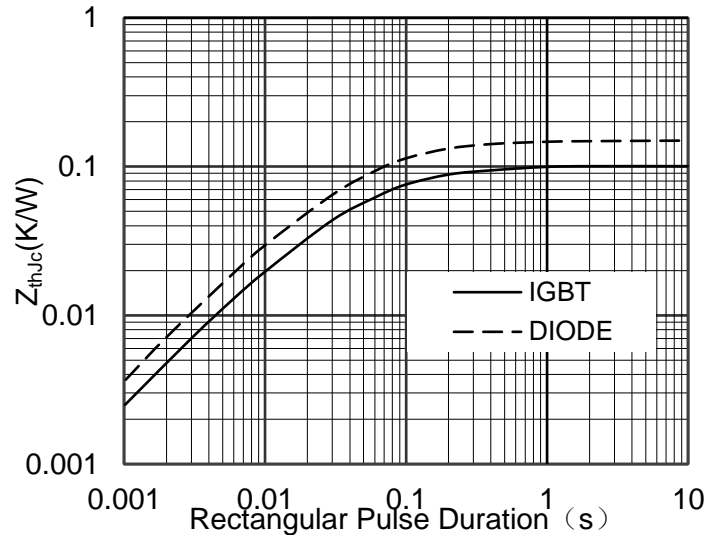
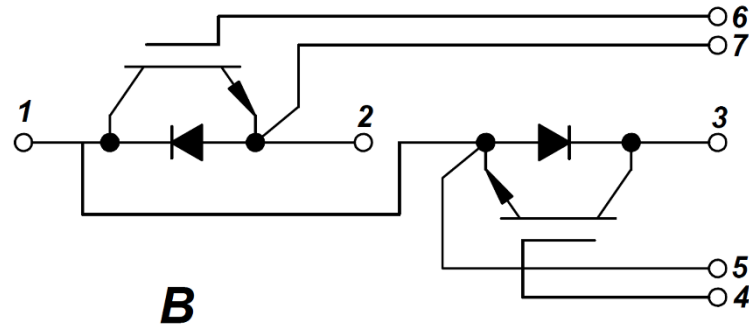
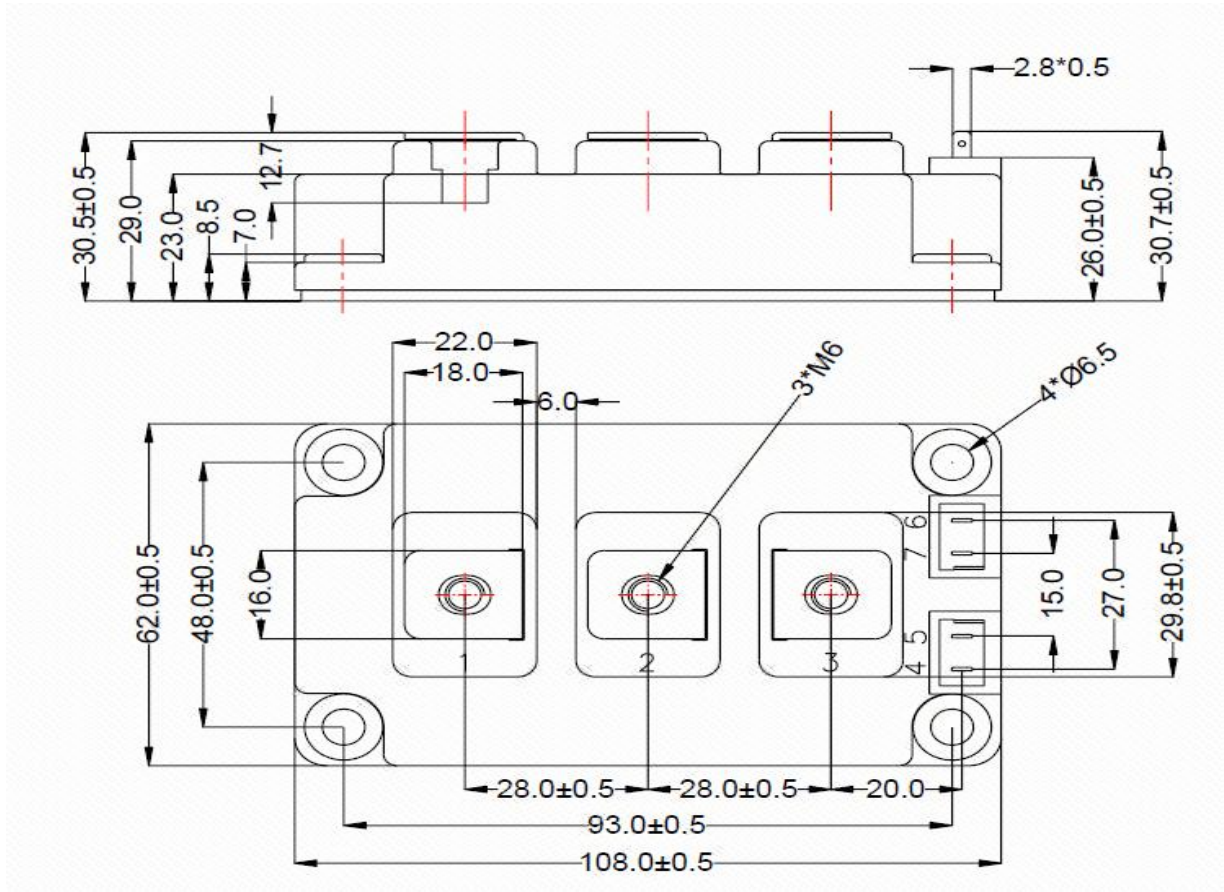

Figure 12. Transient Thermal Impedance of Diode and IGBT-inverter



B

Figure 13. Circuit Diagram



Dimensions in (mm)
Figure 14. Package Outline