

PRODUCT FEATURES

- High speed switching
- $R_{DS(ON),typ}=6\Omega@V_{GS}=10V$
- Fully isolated TO-3PF plastic package

APPLICATIONS

- Switching applications

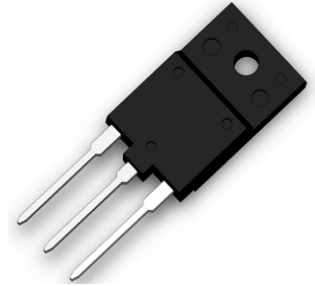
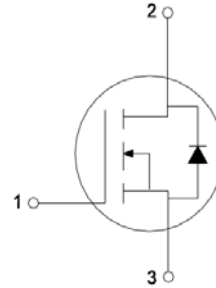

1.GATE
2.DRAIN
3.SOURCE

Type	V_{DS}	I_D	$R_{DS(ON),max}$ $T_J=25^\circ C$	T_{Jmax}	Marking	Package
MM3N150PF	1500V	2.5A	9 Ω	150 $^\circ C$	MM3N150PF	TO-3PF

ABSOLUTE MAXIMUM RATINGS($T_C=25^\circ C$ unless otherwise specified)

Symbol	Parameter/Test Conditions	Values	Unit
V_{DSS}	Drain Source Voltage	$T_J=25^\circ C$	V
V_{GSS}	Gate Source Voltage		
I_D	Continuous Drain Current	$T_C=25^\circ C$	A
		$T_C=100^\circ C$	
I_{DM}	Pulsed Drain Current at $V_{GS}=10V$	Limited by T_{Jmax}	10
P_D	Maximum Power Dissipation		63
E_{AS}	Single Pulse Avalanche Energy ($V_{DD}=50V$)		450
T_{Jmax}	Max. Junction Temperature		150
T_{STG}	Storage Temperature Range		-55~150

THERMAL CHARACTERISTICS($T_C=25^\circ C$ unless otherwise specified)

Symbol	Parameter/Test Conditions	Values	Unit
R_{thJC}	Thermal resistance, junction to case	2	$^\circ C/W$
R_{thJA}	Thermal resistance, junction to ambient	50	

MacMic Science & Technology Co., Ltd.

Add: #18, Hua Shan Zhong Lu, New District, Changzhou City, Jiangsu Province, P. R .of China

Tel.: +86-519-85163708 Fax: +86-519-85162291 Post Code: 213022 Website: www.macmicst.com

MM3N150PF

MOSFET

ELECTRICAL CHARACTERISTICS ($T_C=25^\circ\text{C}$ unless otherwise specified)

Symbol	Parameter/Test Conditions		Min.	Typ.	Max.	Unit	
$V_{(BR)DSS}$	Drain Source Breakdown Voltage	$V_{GS}=0V, I_D=1mA$	1500			V	
$R_{DS(ON)}$	Drain Source ON Resistance	$V_{GS}=10V, I_D=1.3A$		6	9	Ω	
I_{DSS}	Drain Source Leakage Current	$V_{DS}=1500V, V_{GS}=0V$			10	μA	
$V_{GS(th)}$	Gate Threshold Voltage	$V_{GS}=V_{DS}, I_D=250\mu A$	3	4	5	V	
I_{GSS}	Gate Leakage Current	$V_{DS}=0V, V_{GS}=\pm 30V$	-200		200	nA	
R_{gint}	Integrated Gate Resistor			2		Ω	
Q_g	Total Gate Charge	$V_{DD}=1200V, I_D=2.5A, V_{GS}=10V$		34		nC	
Q_{gs}	Gate Source Charge			7		nC	
Q_{gd}	Gate Drain Charge			19		nC	
C_{iss}	Input Capacitance	$V_{DS}=25V, V_{GS}=0V, f=1MHz$		1450		pF	
C_{oss}	Output Capacitance			90		pF	
C_{rss}	Reverse Transfer Capacitance			10		pF	
$t_{d(on)}$	Turn on Delay Time	$V_{DD}=750V, I_D=1.25A,$ $R_G=4.7\Omega,$ $V_{GS}=10V,$ (Resistive Load)	$T_J=25^\circ\text{C}$		32		ns
t_r	Rise Time				67		ns
$t_{d(off)}$	Turn off Delay Time				45		ns
t_f	Fall Time				61		ns

Source-Drain BODY-DIODE CHARACTERISTICS ($T_C=25^\circ\text{C}$ unless otherwise specified)

Symbol	Parameter/Test Conditions		Min.	Typ.	Max.	Unit
I_{SD}	Continuous Source Drain Current				2.5	A
V_{SD}	Forward Voltage	$I_S=2.5A, V_{GS}=0V$			1.6	V
t_{rr}	Reverse Recovery time	$I_F=2.5A, V_{GS}=0V$		415		ns
Q_{RR}	Reverse Recovery Charge	$dI_F/dt=-100A/\mu s$		2300		nC

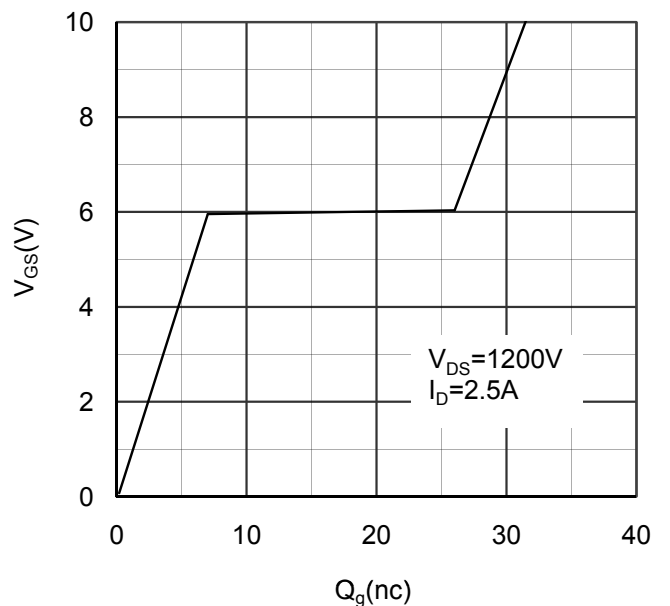
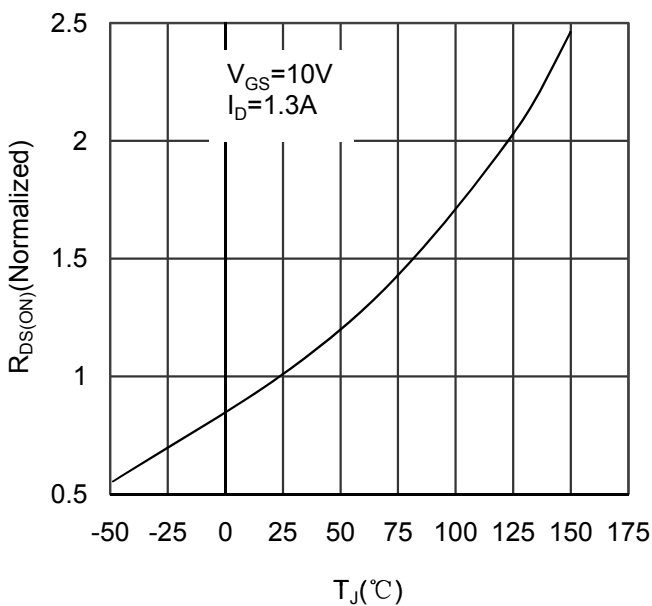
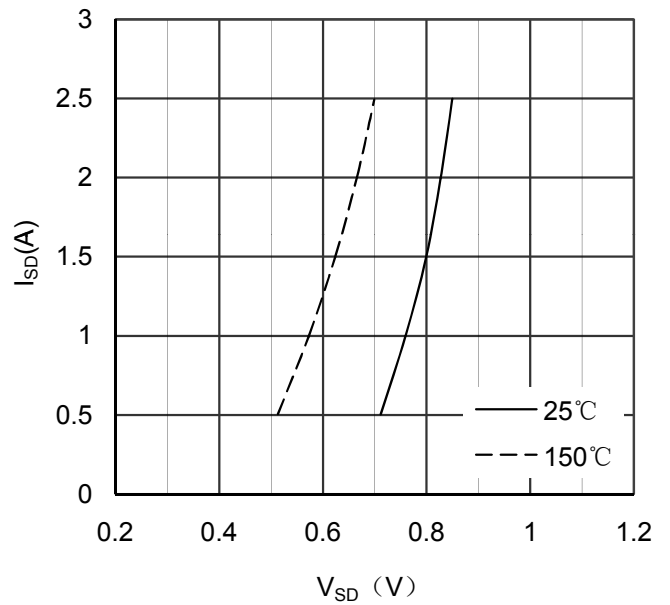
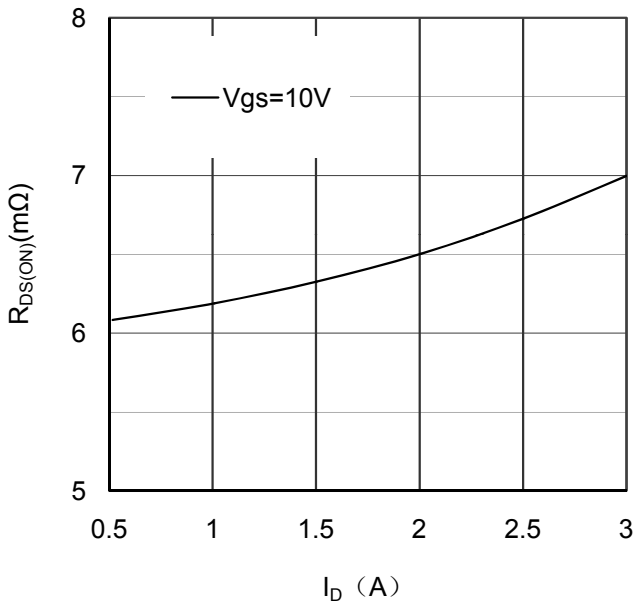
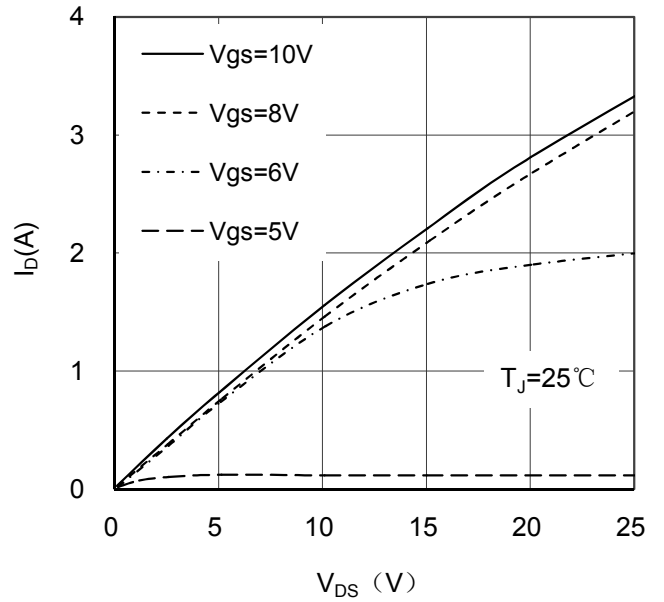
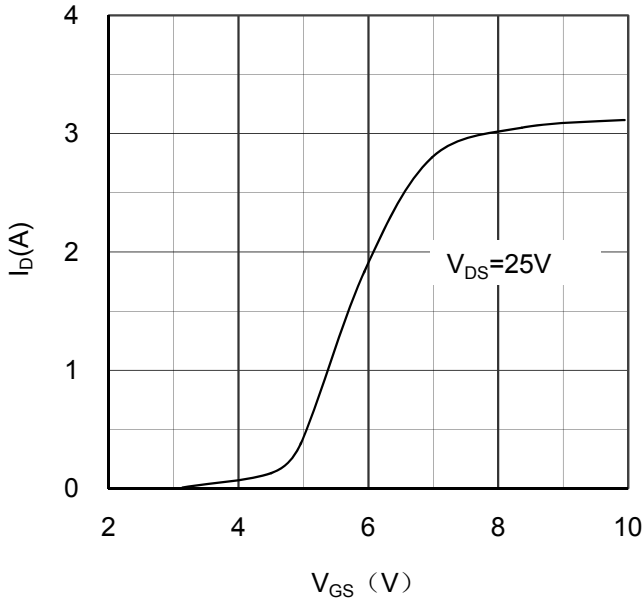

MM3N150PF

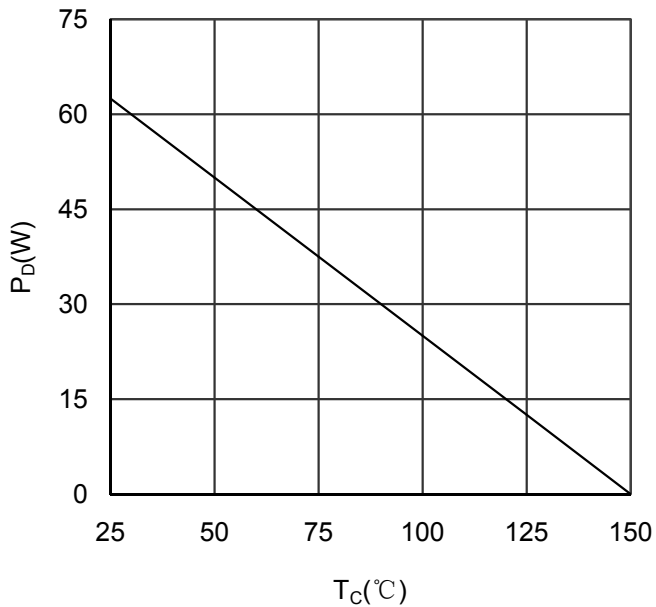

Figure 7. Maximum Power Dissipation vs Case Temperature

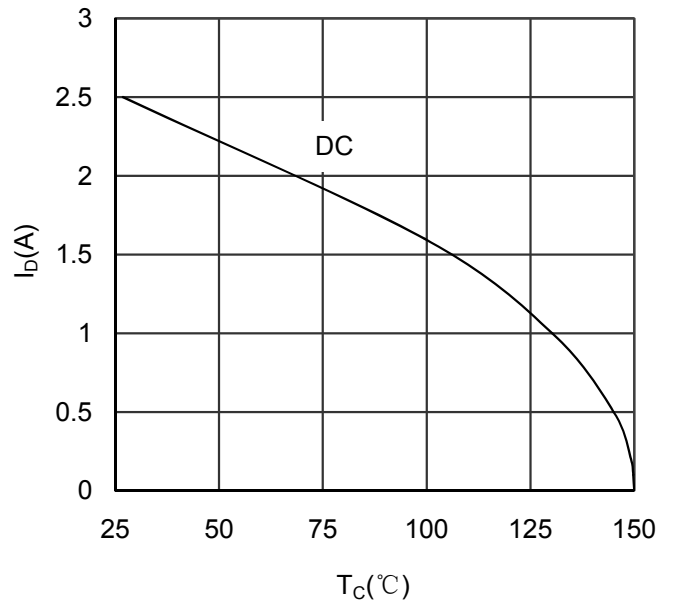

Figure 8. Maximum Continuous Drain Current vs Case Temperature

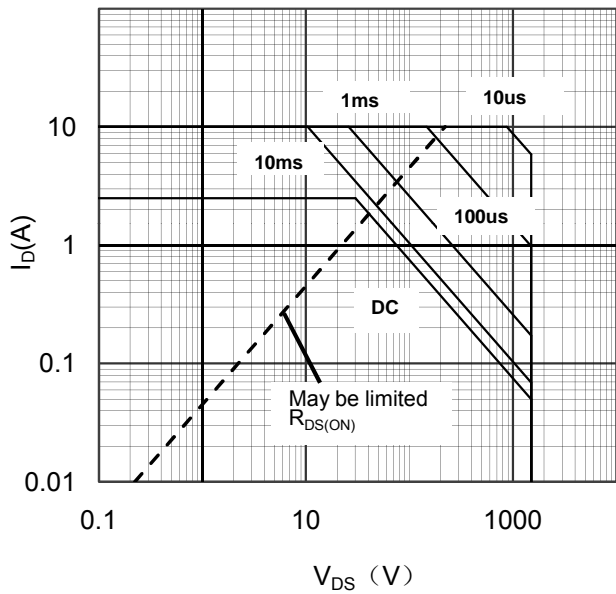

Figure 9. Maximum Forward Safe Operation Area

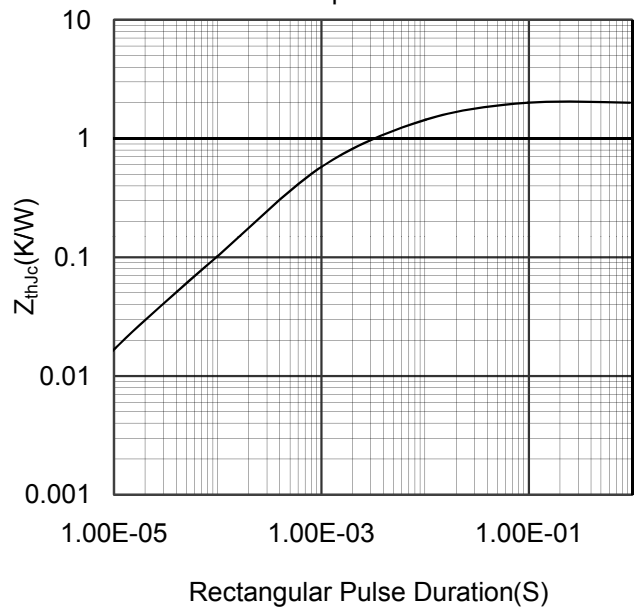
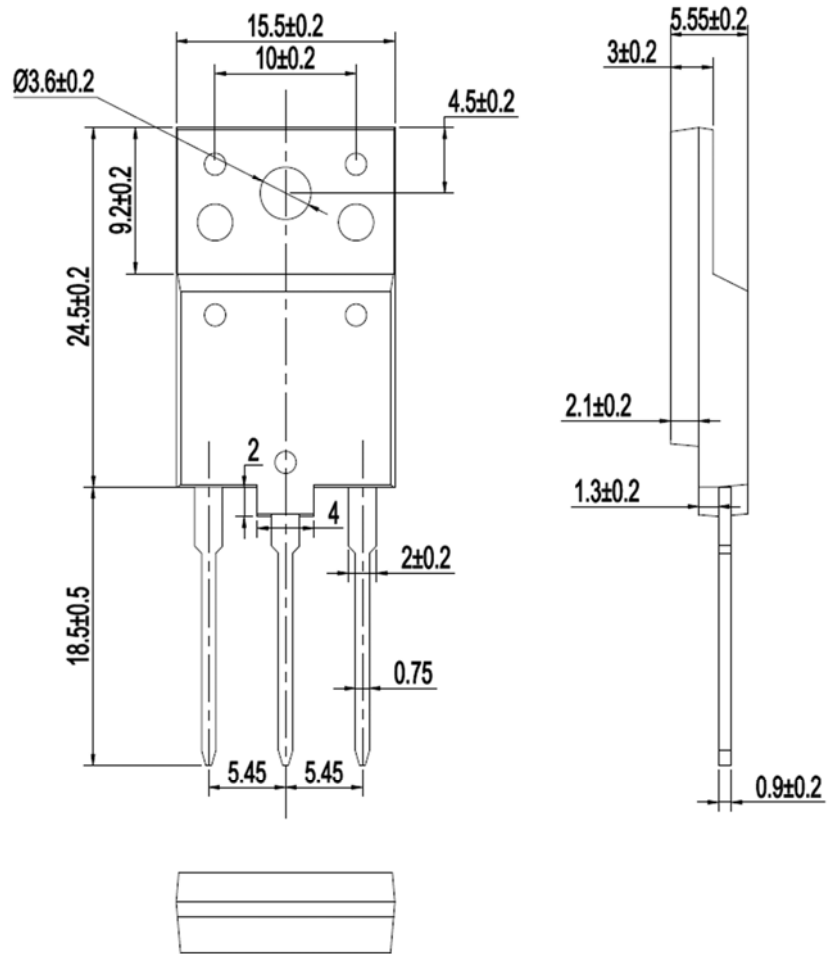

Figure 10. Transient Thermal Impedance



Dimensions in (mm)
Figure 11. Package Outline